

Published by the California Seismic Safety Commission

Homeowner's Guide to Earthquake Safety

2020 EDITION



State of California
Gavin Newsom
Governor

SSC No. 20-01



The *Homeowner's Guide to Earthquake Safety* was developed and published by the California Seismic Safety Commission. It is distributed under the provisions of the Library Distribution Act and Government Code Section 11096.*

*Copyright 2020 by the California Seismic Safety Commission.
All rights reserved.*

Legislation

This guide has been developed and adopted by the California Seismic Safety Commission as required by Assembly Bill 2959, authored by Assemblymember Johan Klehs (Chapter 1499, Statutes of 1990), and by Assembly Bill 200, authored by Assemblymember Dominic Cortese (Chapter 699, Statutes of 1991).

Ordering Information

Single copies of this booklet are available from the

California Seismic Safety Commission

3650 Schriever Avenue
Mather, CA 95655

To order call (916) 263-5506 or download an online copy at
<http://ssc.ca.gov>

*Cover photo: Collapsed two-story home. Nigel Spiers, 2011
Shutterstock, Enhanced License*

**Disclaimer: The effects, descriptions, recommendations and suggestions included in this Guide are intended to improve earthquake preparedness; however, they do not guarantee the safety of an individual or a structure. The California Seismic Safety Commission takes responsibility for the inclusion of material in this Guide. The State of California, the California Seismic Safety Commission, and all contributors to this document do not assume liability for any injury, death, property damage, loss of revenue, or any other effects of earthquakes.*

Effective July 1, 2020, the 2020 edition of the *Homeowner's Guide to Earthquake Safety* replaces the 2005 edition.



Introduction

EARTHQUAKES ARE INEVITABLE IN CALIFORNIA.

They can occur at any time and without warning. They can be extremely destructive and even deadly.

As a current or future owner of a home*, you should be aware of the risks—potentially considerable and catastrophic—that earthquakes pose to your property and to the safety of you and your family.

THIS GUIDE is designed to help you prevent injuries, save lives, and avoid costly property damage from earthquakes. It provides information on:

- The most common earthquake-related hazards that can damage homes
- How to find and then fix the potential structural risks in a home
- How to find more information on earthquake safety

If you sell your home, this Guide also will help you meet your requirements under California law.

There are no guarantees of safety during earthquakes, but properly constructed and strengthened homes are far less likely to collapse or be damaged during earthquakes. The California Seismic Safety Commission advises you to act on the suggestions outlined in this Guide and make yourself, your family, and your home safer.

*In this Guide, "home" means single-family residences, duplexes, triplexes, and four-plexes. Under California law, a seller of a home built before 1960 must fulfill certain disclosure requirements as part of the sales process (see page 4).

USING THIS GUIDE	PAGE
Selling or Buying a Home	4
Earthquake Hazards in California	6
Residential Earthquake Risks & the Disclosure Statement	12
Tips for a Successful Retrofit	26
Earthquake Safety Tips	30
Other Information	34

\$55+
BILLION

Earthquake related losses in California since 1971

\$12+
BILLION

Estimated home damage in the 1994 Northridge Earthquake

Selling or Buying A Home: Requirements & Recommendations

SELLING A HOME

If you are selling a home built before 1960, California law* requires you to:

- Properly strap the water heater.
- Provide buyers with the following documents:
 - A Residential Earthquake Risk Disclosure Statement (page 13), where you identify known home risks
 - A Natural Hazard Disclosure Statement, where you indicate if your home is in an Earthquake Fault Zone or Seismic Hazard Zone. Ask your realtor for a copy of this Disclosure Statement.
 - A copy of this Guide (Your real estate agent is required to give you the Guide.)
 - Note: If you list your home through a real estate agent or broker, you should have him or her give the documentation to the buyer.
- **Note:** Keep a copy of all documentation signed by the buyer as evidence that you complied with the requirements.

Under the law, you are NOT required to:

- Remove siding, drywall, or plaster to complete the disclosure statements.
- Hire someone to evaluate your home or to complete the disclosure statements. You may seek the assistance of a certified home inspector or a licensed contractor, architect, or engineer.
- Fix the risks before you sell your home; on the other hand, making the improvements could increase your home's value.

*A summary of the relevant California laws related to seismic safety is included at the end of this Guide (page 35).



BUYING A HOME

Before you agree to buy a home, you should consider the following:

- Have a certified home inspector, licensed building contractor, engineer, or architect inspect the home and give an opinion on existing earthquake risks and the estimated cost to strengthen the home.
- Check the location of the home to determine if it is in an Alquist-Priolo Earthquake Fault Zone or an area susceptible to landslides, liquefaction, or tsunami. A licensed geotechnical engineer and/or engineering geologist can help you answer these questions and check the stability of the land under the home.
- Negotiate with the seller the cost of any proposed repairs or upgrades. State law does not require either the seller or buyer to strengthen a home against earthquake risks. However, the cost to repair a home after a damaging earthquake may far exceed the costs to strengthen the home and reduce the risks.

Property Tax Exclusion

Under California law (Revenue and Tax Code, Section 74.5), a homeowner can implement seismic-strengthening measures without a property tax reassessment. To receive the exclusion, you must have the work approved by the local building department and file a claim form with your county tax assessor.

Earthquake Insurance

Typically, residential property insurance does **not** include earthquake coverage. A homeowner may purchase a separate earthquake policy. Information on earthquake insurance is on page 37.

Earthquake Hazards

KNOW IF YOUR HOME IS AT RISK

Earthquakes occur in California every day. As a homeowner, you should know if your home is in an area that is more prone to earthquakes or if the geology or soil conditions of your neighborhood or community present greater risk during an earthquake. The more you know, the better able you are to take appropriate precautions to protect your home and family.

Is your home near an active earthquake fault or an area prone to severe shaking?

See the maps on pages 10 & 11.

Requirements under the law: If you are selling your home or any other type of real estate, no matter its age, you must disclose to buyers information about natural hazards that can affect the property, including flood and fire hazards and earthquake hazards. You report this information on the Natural Hazard Disclosure Statement.

The most common earthquake-related natural hazards are **ground shaking, fault ruptures, landslides, liquefaction, and tsunami**. In addition, earthquake damage to a dam can be a hazard to "downstream" homes.



Earthquake Hazards

GROUND SHAKING



Guy Morrow, 2004

In California, ground shaking causes 99% of earthquake damage to homes. Homes in areas near large active faults are more likely to feel severe shaking—and experience damage—than homes in other areas of the state.

FAULT RUPTURE



A strong earthquake can cause the two sides of a fault to suddenly slide by one another. Even a relatively minor fault rupture can cause foundation and structural damage requiring expensive repairs.

Pilar Villamor, GNS Science, 2016

Earthquake Hazards

LANDSLIDE



Earthquake shaking can be strong enough to cause soil and rock on a hillside to slide down the slope. A landslide can rip apart homes at the top of the slope and also crush homes at the bottom of the slope.

Al Seib, Los Angeles Times, 1994

LIQUEFACTION



Graeme Beattie, BRANZ, 2011

Strong ground shaking can cause liquefaction—excess pore water pressure that reduces the soil's ability to support structures. Liquefaction can cause structures to tilt or collapse.



Earthquake Hazards

TSUNAMI



National Oceanographic and Atmospheric Administration, 1964

California's coastal areas are prone to damage from tsunami—a series of large ocean waves caused by an underwater earthquake or landslide. Tsunami waves can travel a great distance and cause flooding or wash away structures in low-lying areas along the shore, in and along harbors, and along the banks of rivers. Tsunamis generated by the 1964 Alaskan earthquake (magnitude 9.2) and the 2011 Japan earthquake (magnitude 9.0) caused property damage and loss of life in California.

Is your home at risk of a tsunami?

Check with your County's office of emergency services.

DAM FAILURE



E. V. Leyendecker, United States Geological Survey, 1971

A very strong earthquake could damage a dam, resulting in sudden and devastating flooding of nearby homes. The 1971 San Fernando earthquake damaged the Lower San Fernando Dam, which sits less than half-mile above the neighborhoods of the San Fernando Valley in southern California. The risk of an aftershock forced the three-day evacuation of residents of an 11-square-mile area.

Is your home near a dam?

Check with your County's office of emergency services for a dam inundation map, which shows the location of major dams and areas that could flood in the event of a dam failure.

BETTER SAFE THAN SORRY

If you live in a low-lying coastal area or an area near a dam (dam inundation zone), know where to evacuate to higher ground and be prepared to evacuate immediately after an earthquake.

Earthquake Shaking Potential for California

This map shows the relative intensity of ground shaking in California from anticipated future earthquakes and significant earthquakes that have occurred since the Great 1857 magnitude 7.9 Fort Tejon earthquake. Although the greatest hazard is in areas of highest intensity as shown on the map, no region is immune from potential earthquake damage.

\$3+
BILLION
PER YEAR

Expected long-term average earthquake damage in California

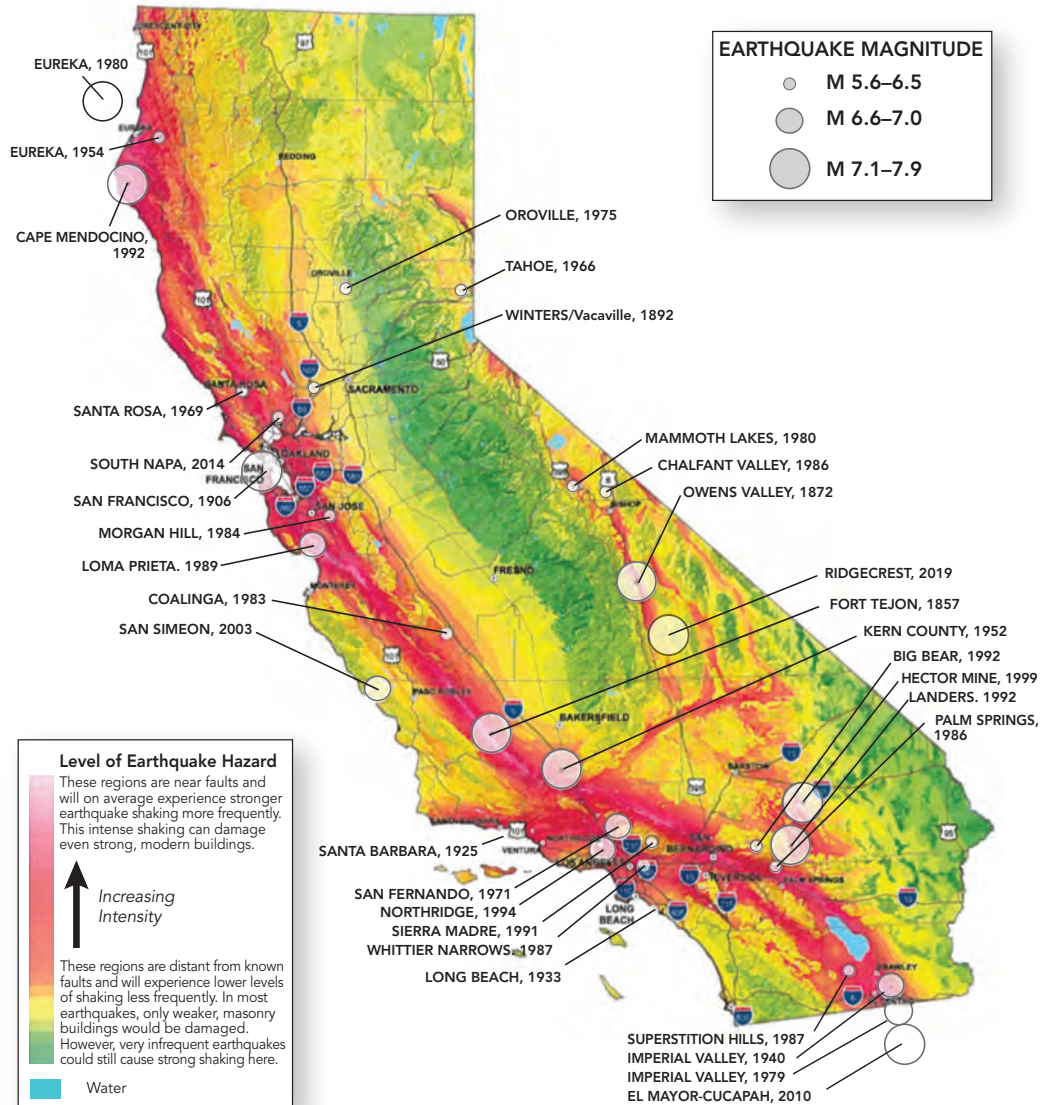



Significant Historical Earthquakes and Their ShakeMaps

The ShakeMaps (inserts) show areas of moderate-to-heavy ground shaking in four historical earthquakes.

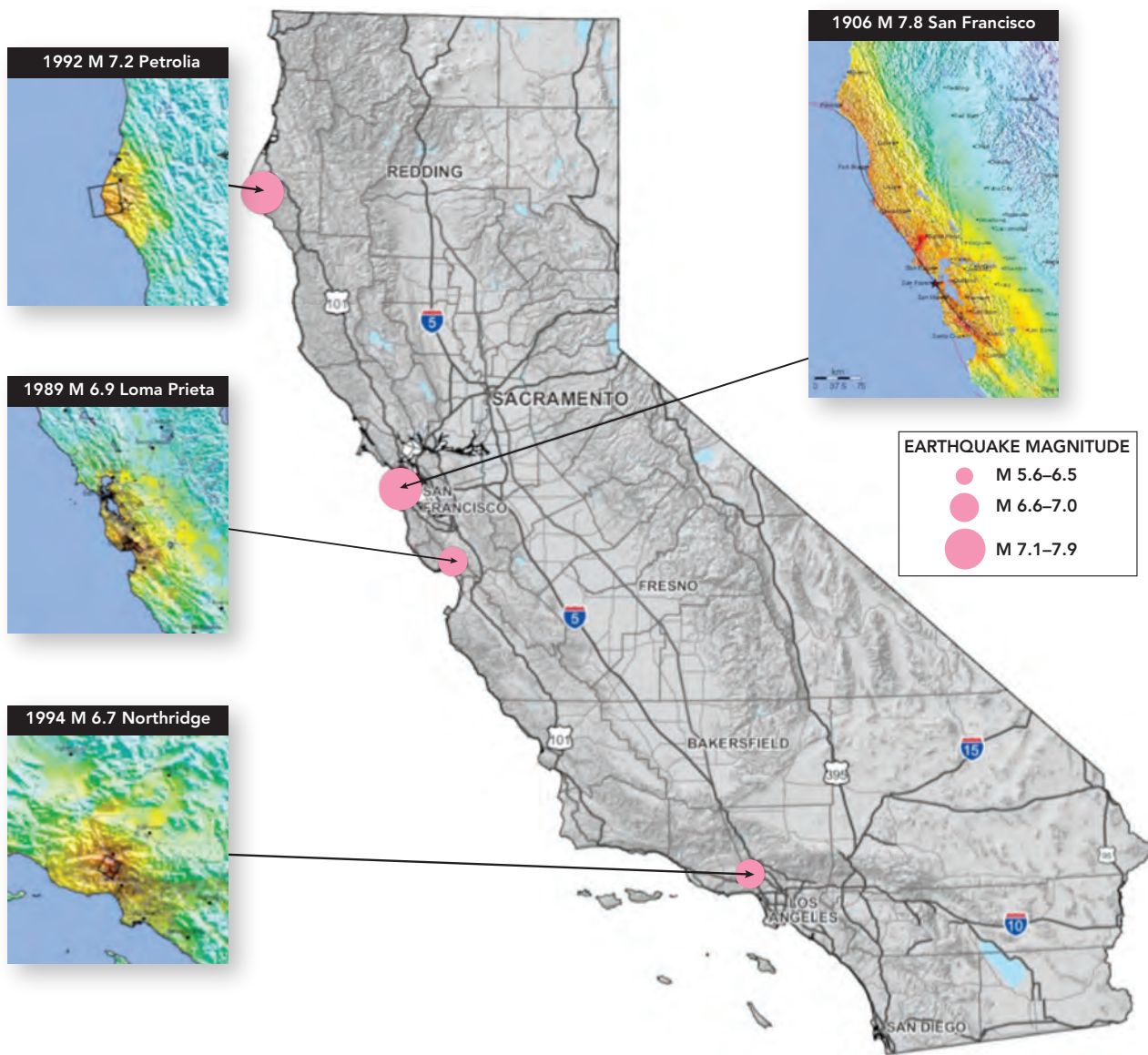

ShakeMap Explanation

INSTRUMENTAL INTENSITY	I	II-III	IV	V	VI	VII	VIII	IX	X+
PERCEIVED SHAKING	NOT FELT	WEAK	LIGHT	MODERATE	STRONG	VERY STRONG	SEVERE	VIOLENT	EXTREME
POTENTIAL DAMAGE	NONE	NONE	NONE	VERY LIGHT	LIGHT	MODERATE	MOD/HEAVY	HEAVY	VERY HEAVY

Source: USGS

Residential Earthquake Risks & the Disclosure Statement

Earthquakes in California can occur at any time and without warning. To prevent injuries and avoid costly property damage, homeowners should determine the potential for earthquake risks in their homes and then retrofit or upgrade these conditions. If not corrected, these risks can lead to:

- Severe property damage, including foundation damage and damage to floors, walls, and windows
- Loss of personal property
- Broken utilities, which can result in fire, water damage, and spread of toxic substances
- Personal injuries

In addition, under California law, sellers of homes built before 1960 must disclose known earthquake risks to buyers as part of the property sales process.

Completing the Residential Earthquake Risk Disclosure Statement

When you sell a home built before 1960, you are required to fill out the Residential Earthquake Risk Disclosure Statement, (see next page) and give the completed statement to the buyer. You are required to answer each question to the best of your knowledge.

To complete the Disclosure Statement, answer:

- “Yes” if you know your home is protected from the risk (e.g., for Item #1, answer “Yes” if your home’s water heater is properly braced)
- “No” if you know your home is at risk (e.g., for Item #6, answer “No” if your home’s exterior brick walls are not strengthened)
- “Doesn’t Apply” if the question is not relevant to your home (e.g., for Item #7, answer “Doesn’t Apply” if your home does not have a living space over the garage)
- “Don’t Know” if you do not have adequate information to answer the question

IN THIS SECTION PAGE

Completing the Residential Earthquake Risk Disclosure Statement	12-13
Identifying and Disclosing Earthquake Risks	14-25
Water Heaters	14
Unbolted Foundations	15
Crawl Space (Cripple) Walls	17
Pier-and-Post Foundations	18
Unreinforced Masonry Foundations	19
Hillside Homes	20
Unreinforced Masonry Walls	21
Rooms over Garages	22
Unreinforced Masonry Chimneys	23
Inadequate Foundation	24
Homes with Unique Designs	25

You are not required to remove siding, drywall, or plaster or to hire an inspector to determine the answer to a question. Also, you are not required to fix or retrofit your home before you sell the property.



Residential Earthquake Risk Disclosure Statement (2020 Edition)

Name _____ Assessor's Parcel No. _____

Street Address _____ Year Built _____

City _____ County _____ Zip Code _____

Answer these questions to the best of your knowledge. If any of the questions are answered "No," your home is likely to have an elevated/disclosable earthquake risk. If you do not have actual knowledge as to whether these risks exist, answer "Don't Know." Questions answered "Don't Know" may indicate a need for further evaluation. If your home does not have the feature, answer "Doesn't Apply." If you corrected one or more of these risks, describe the work on a separate page. The page numbers in the right-hand column indicate where in this guide you can find information on each of these features.

	Yes	No	Doesn't Apply	Don't Know	See Page
1. Is the water heater braced to resist falling during an earthquake?	<input type="checkbox"/>	<input type="checkbox"/>	<input type="checkbox"/>	<input type="checkbox"/>	14
2. Is your home bolted to its foundation?	<input type="checkbox"/>	<input type="checkbox"/>	<input type="checkbox"/>	<input type="checkbox"/>	15
3. If your home has crawl space (cripple) walls:					
a. Are the exterior crawl space (cripple) walls braced?	<input type="checkbox"/>	<input type="checkbox"/>	<input type="checkbox"/>	<input type="checkbox"/>	17
b. If the exterior foundation consists of unconnected concrete piers and posts, have they been strengthened?	<input type="checkbox"/>	<input type="checkbox"/>	<input type="checkbox"/>	<input type="checkbox"/>	18
4. If the exterior foundation, or part of it, is made of unreinforced masonry, has it been strengthened?	<input type="checkbox"/>	<input type="checkbox"/>	<input type="checkbox"/>	<input type="checkbox"/>	19
5. If your home is on a hillside:					
a. Are the exterior tall foundation walls braced?	<input type="checkbox"/>	<input type="checkbox"/>	<input type="checkbox"/>	<input type="checkbox"/>	20
b. Are the tall posts or columns either built to resist earthquakes or have they been strengthened?	<input type="checkbox"/>	<input type="checkbox"/>	<input type="checkbox"/>	<input type="checkbox"/>	20
6. If the exterior walls of your home are made of unreinforced masonry, either completely or partially, have they been strengthened?	<input type="checkbox"/>	<input type="checkbox"/>	<input type="checkbox"/>	<input type="checkbox"/>	21
7. If your home has a room over the garage, is the wall around the garage door opening built to resist earthquakes or has it been strengthened?	<input type="checkbox"/>	<input type="checkbox"/>	<input type="checkbox"/>	<input type="checkbox"/>	22
8. Is your home outside an Alquist-Priolo Earthquake Fault Zone (an area immediately surrounding known active earthquake faults)?	<i>To be reported on the Natural Hazard Disclosure Statement</i>				
9. Is your home outside a Seismic Hazard Zone (an area identified as susceptible to liquefaction or a landslide)?	<i>To be reported on the Natural Hazard Disclosure Statement</i>				

As seller of the property described herein, I have answered the questions above to the best of my knowledge in an effort to disclose fully any potential earthquake risks it may have.

EXECUTED BY

Seller Seller Date

I acknowledge receipt of the *Homeowner's Guide to Earthquake Safety* and this Disclosure Statement, completed and signed by the seller. I understand that if the seller has answered "No" to one or more questions, or if the seller has indicated a lack of knowledge, there may be one or more earthquake risks in this home.

Buyer Buyer Date

This Disclosure Statement is made in addition to the standard real estate transfer disclosure statement also required by law.

Earthquake Risk Disclosure Statement Item 1



During an earthquake, an unbraced water heater can topple, which can start a fire or lead to major water damage.

Is your home's water heater braced?

If your home's water heater is not properly braced, or if it has rigid rather than flexible pipes, the water heater may move or topple during an earthquake. This movement can break gas or water lines, resulting in fire, water damage, or release of toxic gas.

Under California law, you are required to brace your home's water heater whenever you install a new water heater or if you sell the home.

How to Check for Proper Water Heater Bracing

1. Examine your home's water heater.
2. Look for two sets of straps that wrap around the water heater and securely bolt the water heater to the wall and wall studs (see diagram).

Tankless Water Heater?

If you have a tankless water heater, be sure it is securely attached to the wall and that its pipes are installed according to the manufacturer's instructions.

PROPER WATER HEATER BRACING

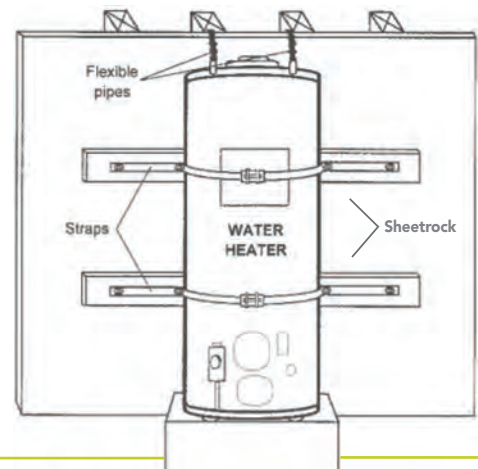

WANT TO RETROFIT?

Find out more on pages 26-29.



Earthquake Risk Disclosure Statement Item 2

Is your home bolted to its foundation?

If your home is not bolted to its foundation, it could slide off the foundation during an earthquake.

- A home that has moved can cause gas, water, and sewer lines to break, resulting in fire, water damage, and release of toxic fluids.
- Lifting a home back onto its foundation is difficult and expensive.

How to Check for Foundation Bolting

1. Determine if your home has a crawl space, which will be below the first floor.
Clue: If your home has steps leading to an exterior door, the home probably has a crawl space. If you have no steps, the home is most likely built on a concrete slab and has no crawl space. If you do not have a crawl space, see "What If" section on next page.
2. Go into the crawl space. Access will be through a small removable panel or door along an exterior wall or from inside the garage.
3. Look for areas of unfinished wood framing at base of walls (see diagram). If the crawl space has finished wood framing, see "What If" section.
4. Find sill plates (wood boards that sit directly on top of foundation) and look for anchor bolts that fasten sill plates to foundation (see diagram on next page).
 - **Adequate bolting:** Bolts with nuts and square washers spaced every 4 to 6 feet
 - **Inadequate bolting:** No visible bolts



WANT TO RETROFIT?
Find out more on pages 26-29.

WHAT IF . . .

Q My home does not have a crawl space?

A Particularly after 1960, many California homes were built directly on concrete slabs. Fortunately, most of these homes and other post-1960 homes built to code have anchor bolts.

Q The crawl space has finished framing, so I cannot see the sill plates or anchors?

A You are not required to remove siding, drywall or plaster to determine if your home's foundation has anchor bolts.

For both situations, check "Don't Know" on the Disclosure Statement.

LOCATING FOUNDATION BOLTS

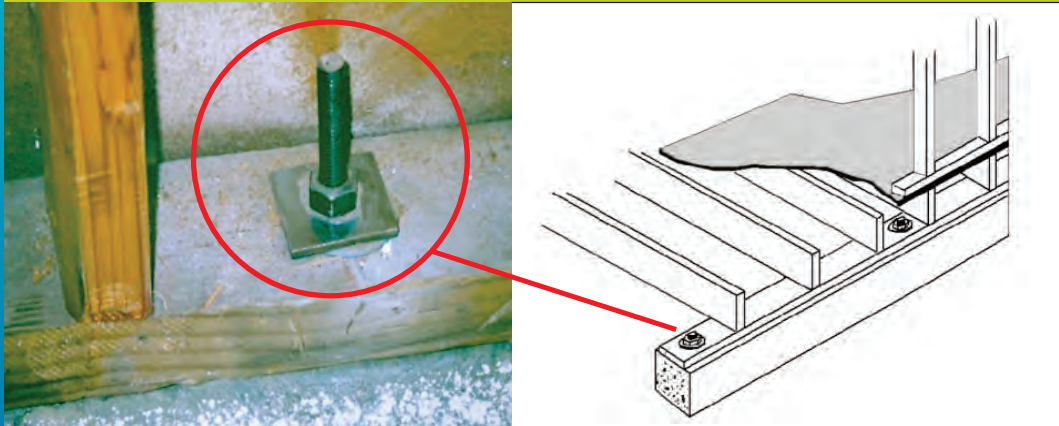

WANT TO RETROFIT?

Find out more on pages 26-29.



Earthquake Risk Disclosure Statement Item 3a

Are your crawl space (cripple) walls braced?

If your home has a crawl space with un-braced walls, these crawl space (cripple) walls could collapse during an earthquake, which, in turn, may cause your entire home to collapse or lead to major damage to the structure as well as possible fire, water line breaks and injuries.



This older home collapsed after earthquake shaking damaged its crawl space (cripple) walls.

How to Check for Bracing of Crawl Space Walls

1. Determine if your home has a crawl space with cripple walls.
 - Clue:** If your home has three or more steps leading to an exterior door, the home has a crawl space below the first floor and, therefore, has cripple walls.
2. Go into the crawl space. Access will be through small removable panel or door along an exterior wall or from inside the garage.
3. Examine the inside surfaces of the exterior walls.
 - **Adequate bracing:** Plywood or diagonal sheathing on exterior walls (see diagrams)
 - **Inadequate bracing:** No plywood or diagonal sheathing

PLYWOOD OR ORIENTED STRAND BOARD

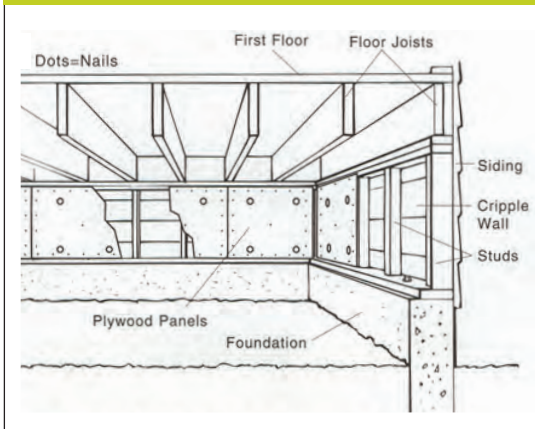

DIAGONAL SHEATHING

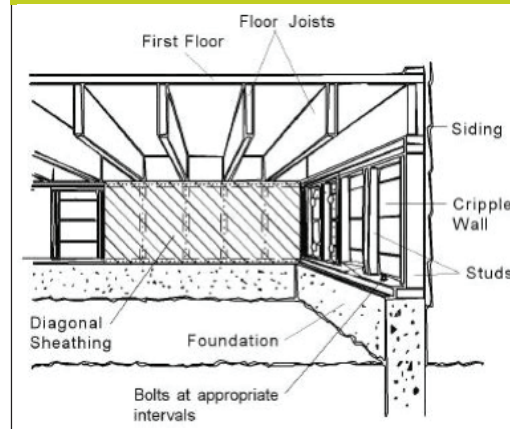

WANT TO RETROFIT?
Find out more on pages 26-29.

Earthquake Risk Disclosure Statement Item 3b

Is your home's pier-and-post foundation strengthened?

If your home sits on large wood posts that rest on unconnected concrete piers, the posts may not be braced properly. During an earthquake, the posts could fail and your home could shift or collapse.

How to Check for Pier-and-Post Foundation Strengthening

1. Go under the home and determine the type of foundation that supports the exterior walls.
 - Continuous perimeter foundation wall (check "Does Not Apply" on the statement)
 - Concrete piers and wood posts
2. For concrete piers and wood posts, look further to determine if the foundation is adequately braced or strengthened.
 - **Adequate bracing:** A continuous foundation around the perimeter edges of the home that consists of either reinforced concrete or reinforced masonry.
 - **Inadequate bracing** along the perimeter edges of the home:
 - Wood posts supported by concrete piers, or
 - Wood posts without concrete piers or continuous perimeter foundations



This home's pier-and-post foundation was damaged during an earthquake. The diagonal bracing was added after the earthquake to temporarily stabilize the home during repairs.



WANT TO RETROFIT?

Find out more on pages 26-29.



Earthquake Risk Disclosure Statement Item 4

Is your home's unreinforced masonry foundation strengthened?

If your home is supported by a brick, stone or concrete block foundation that lacks steel reinforcing, the foundation may not be able to resist earthquake shaking. Your home could slide off its foundation during an earthquake, damaging the walls and floors, rupturing utility connections, and destroying the contents of your home. This, in turn, could lead to fire, water damage, and injuries.



How to Check an Unreinforced Masonry Foundation

1. Walk around the perimeter of your home to determine the composition of the foundation. If the foundation has siding or a plaster finish, you will need to check the foundation from inside the crawl space.
 - Solid concrete foundation (check "Does Not Apply" on the statement)
 - Unreinforced brick, stone, or concrete block foundation
2. For unreinforced brick, stone, or concrete block foundation, look further to determine if the foundation is adequately braced or strengthened (e.g., steel plates attached to foundation walls). If you do not know what to look for, consult a licensed engineer or architect.



WANT TO RETROFIT?
Find out more on pages 26-29.

Earthquake Risk Disclosure Statement Item 5



The balcony of this hillside home partially collapsed and the home tilted when the stilt-type support posts and poorly braced walls shifted during an earthquake.

Does the foundation of your hillside home have adequate support?

Hillside homes require special engineering to resist earthquake shaking.

If your home is built on a hillside and the home's tall foundation walls and stilt-type support posts are not properly braced, your home could collapse during an earthquake, causing severe damage to the home and injuries.

How to Check the Foundation of a Hillside Home

1. Walk around the perimeter of your home to examine both the tall foundation walls and the tall posts or columns that support the home.
2. Examine the exterior tall foundation walls for evidence of extensive wall bracing below the home.
3. If you do not know what to look for, consult a licensed engineer or architect.



WANT TO RETROFIT?

Find out more on pages 26-29.



Earthquake Risk Disclosure Statement Item 6

Are your home's unreinforced masonry walls strengthened?

If your home has walls built of unreinforced masonry—brick, hollow clay tiles, stone, concrete blocks, or adobe—the walls may be too brittle to resist earthquake shaking. As a result, the walls could collapse in an earthquake.



How to Check for Unreinforced Masonry Walls

1. Walk around the perimeter of your home to examine the composition of the exterior walls. Look for evidence of unreinforced brick, clay tile, stone, adobe, or concrete-block wall construction.
 - Look closely at wall surfaces at windows and doors.
 - If the exterior walls are covered with plaster, examine the walls from inside the home (e.g., beneath light switch plates).
2. If the exterior walls are built of masonry, check further for the strength of construction or for indicators of retrofit. Steel plates and anchor bolts are common retrofits (see photo).
3. If you do not know what to look for, consult a licensed engineer or architect.

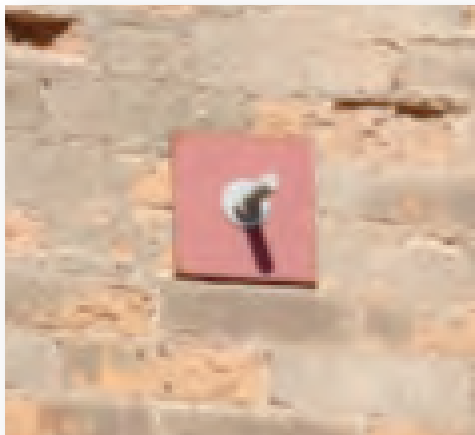

A steel plate with anchor bolts.



WANT TO RETROFIT?
Find out more on pages 26-29.

Earthquake Risk Disclosure Statement Item 7



The walls around the garage door of this home were not strong enough to withstand the shaking of the 1989 Loma Prieta Earthquake.

Does your home have a room above the garage?

If your home has a room above the garage, you need to ensure that the narrow walls on either side of the garage doorway are strong enough to withstand earthquake shaking. Without adequate support, these walls could collapse, causing serious damage and injuries.

How to Check the Strength of a Garage with a Room Above

1. Go into your garage and examine the walls on both sides of the garage doorway. If the garage has been built or strengthened to support a second story, you will see plywood bracing on the walls and metal straps (see diagram).
2. If you do not know what to look for, consult a licensed engineer or architect.

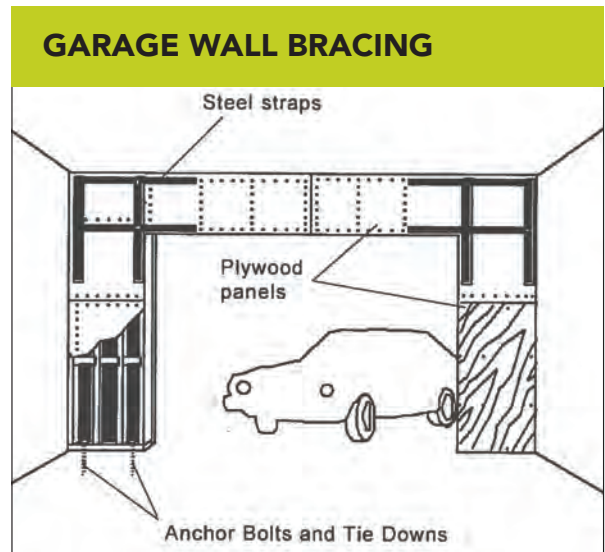

Adequate bracing for a garage wall includes plywood and metal straps.



WANT TO RETROFIT?

Find out more on pages 26-29.



Other Structural Risks

Your home also may have other structural issues that could result in serious property damage or injuries during an earthquake. These risks are not included in the Residential Earthquake Risk Disclosure Statement because, typically, it is not cost effective to complete a retrofit. On the other hand, these risks should be considered if you are a homeowner or a potential home buyer.

UNREINFORCED MASONRY CHIMNEY

If your home has an unreinforced brick or stone chimney, it could collapse during an earthquake and fall on the ground beside the home or fall through the roof into your home (see photos).

How to Check Your Chimney

To determine if your chimney will withstand an earthquake:

1. Check the mortar with a screwdriver. If the mortar crumbles, it may be too weak to withstand earthquake shaking.
2. Access the attic area above the fireplace to verify that the chimney is securely attached to the home with metal straps or ties.
3. If you are unable to verify the strength of the chimney, consult a licensed engineer or architect or a general contractor.

How to Protect against Damage and Injuries (Safety Precautions)

- Avoid parking cars or locating patios or children's play areas within the falling radius of a chimney.
- Remind home occupants to stay away from chimneys and fireplaces during earthquakes.



California Earthquake Authority, 2014



Bay Area Regional Earthquake Preparedness Project, 1989



WANT TO RETROFIT?
Find out more on pages 26-29.

Other Structural Risks

INADEQUATE FOUNDATION

A wood foundation or a foundation of concrete or masonry that is cracked or crumbling may not have the strength to withstand earthquake shaking.

How to Check the Condition of Your Foundation

Determining if a foundation is susceptible to earthquake damage can be a challenge, and the advice of a licensed engineer or architect or a foundation contractor may be necessary.

Wood foundation: In the past, some homes were built on wood beams laid directly on the ground without concrete or masonry supports. If you do not see concrete or masonry foundation walls along the perimeter of your home, your home may have a wood foundation.

Deteriorating masonry: Older concrete or stone foundations can deteriorate over time and become too weak to withstand earthquake shaking. Large cracks, crumbling, or rock pockets are visual signs of deterioration. You also can poke a screwdriver into a foundation wall to check its strength; if the concrete or stone crumbles easily, the foundation may be vulnerable to earthquake damage.



WANT TO RETROFIT?

Find out more on pages 26-29.



Other Structural Risks

HOMES WITH UNIQUE DESIGNS

If not designed adequately and with earthquakes in mind, homes with unique designs can be prone to damage from earthquake shaking.

Unique design features include homes with:

- Large porches or overhangs
- Large windows or window walls
- Three or more stories
- Irregular shapes

Evaluation and Options

In many cases, homes with unique designs have been built to withstand earthquake shaking. Identifying if a home has been strengthened can be difficult. Consulting with a licensed engineer or architect for a seismic evaluation can be helpful.



You can make large windows safer by applying plastic film to the glass.



WANT TO RETROFIT?
Find out more on pages 26-29.

Tips for a Successful Retrofit

MAKE A PLAN: DEFINE THE SCOPE OF WORK AND HOW TO ACCOMPLISH THE PROJECT

The first step in an earthquake retrofit or upgrade is to ensure that you, as the homeowner, understand the work that will be required for the retrofit project and the required building and performance standards. You should not rush into repairs, no matter how badly they are needed, or hire the first contractor you meet with.



Define Scope of Work

Defining the scope of a retrofit or upgrade project is a critical first step. Additional resources are listed on page 34.

Reminders:

- For any retrofit project, be sure to consult with your local building department for advice on the State's requirements, local building codes and standards.
- To determine the best solution for a retrofit, you may want to consult a licensed engineer or architect or a general contractor that specializes in this type of work.
- You or your contractor will need to obtain a building permit from your local building department.
- When evaluating the cost of a retrofit, remember to consider both the economic value of the work and the value to your "peace of mind."



Water Heater Bracing

Under California law, you are required to brace the water heater when you install a new water heater and when you sell your home.

You can brace a water heater yourself using a strap kit, available from a local hardware store. Or, you can hire a plumber or handyperson to do the work. The diagram on page 14 illustrates proper water heater bracing.

As an added safety precaution, consider having a licensed plumber replace any rigid pipes with flexible pipes, which will better withstand shaking during an earthquake.

Simple Retrofit Projects

The *California Existing Building Code, Appendix A, Chapter A3* contains how-to information for retrofitting. *FEMA P-1100, Volume 2A* is also easy to use and accepted for retrofits by local building departments. Do-it-yourself homeowners can undertake simple retrofits without hiring an engineer, architect, or contractor.

Types of Simple Retrofit Projects

- **Foundation bolting:** To add or retrofit a foundation bolting system requires drilling new holes into the foundation and installing bolts.
- **Crawl space wall bracing:** To add or retrofit the wall bracing in a crawl space requires nailing new plywood or oriented strand board to crawl space studs. **Note:** For crawl spaces taller than four feet, consult *FEMA P-1100, Volume 2A*.

More Complicated Retrofit Projects

By their nature, some earthquake retrofit projects are more complicated and will require the expertise of a licensed engineer or architect and/or a general contractor who specializes in this type of work.

- **Pier-and-post foundation:** You may be able to strengthen a pier-and-post foundation system adequately with bracing; alternatively, the best solution may be to install a new, continuous foundation.

- **Unreinforced masonry foundation:** You may be able to replace or supplement all or part of an existing foundation with a new reinforced concrete or masonry foundation.
- **Other inadequate foundation:** If your home's foundation is inadequate (see pages 19, 24), you may need to add a new or replace an existing foundation to reduce the risks of earthquake damage.
- **Unreinforced masonry walls:** In most cases, retrofitting unreinforced masonry walls requires 1) better connecting the walls to the roof and floors and 2) installing steel frames or reinforced concrete. In some cases, large steel plates must be attached with anchor bolts through the masonry (see photo on page 21). Engineering information is in the *California Existing Building Code, Appendix A, Chapter A1*.
- **Unreinforced masonry chimney:** Strengthening or bracing a chimney can be expensive. Retrofit options include:
 - o Adding plywood panels either above ceiling joists or, when re-roofing, on roof framing
 - o Removing or replacing all or a portion of the chimney with lighter-weight material (e.g., using a metal flue for the upper portion of a chimney). (see *FEMA P-1100, Volume 2C*)
- **Garage walls:** Engineering information on retrofitting garage walls is in the *California Existing Building Code* or *FEMA P-1100, Volume 2B*.
- **Hillside homes:** Retrofitting hillside homes includes strengthening foundations, walls, columns and diagonal bracing. Engineering information is in the *California Existing Building Code* or the *FEMA P-1100* publication.
- **Historical homes:** Your project will need to comply with the *California Historical Building Code*.

Keep Your Retrofit Documents

Once your project is complete, remember to keep all plans, permits, and other project records so you can provide them to a future home buyer.



Select a Licensed Contractor

A critical step is to find and hire the right contractor for your job.

Be sure you:

- Discuss your project with at least two and, ideally, more licensed contractors.
- Obtain a written proposal from each contractor. Do not accept verbal promises. Be sure to compare the proposals to ensure the scope of work in each proposal (project description) meets your needs and are similar. Examine all terms of the proposal (e.g., price, project plan and timeframe, use of subcontractors). Consider each contractor's experience with residential earthquake retrofitting. The lowest-priced bid may not be the best bid.
- Ask for and then check with references.
- Before finalizing a contract, verify that your preferred contractor's state license is current and that your contractor is licensed to do business in your community.



You will find useful a number of publications from the Contractor's State License Board. Visit www.cslb.ca.gov.

- *What You Should Know before Hiring a Contractor:*
Provides information on how to find, hire and work with a contractor
- *A Consumer Guide to Home Improvement Contracts:*
Provides information on the legal obligations of home improvement contractors

Avoid Contractor Payment Pitfalls

- For any project that costs \$500 or more, a licensed contractor must provide a written contract.
- Pay the contractor in installments as the work is completed.
 - Keep the down payment low. By law, a down payment on a home improvement contract cannot exceed 10% of the contract price or \$1,000, whichever is less.
 - Withhold at least 10% of the total contract price until the project is completed to your satisfaction.
 - Do not make the final payment until the local building department has signed off on the work and you have conducted a final review of the work to make sure it is complete and correct.

Earthquake Safety Tips

Precautions: During an Earthquake

If you are indoors: Drop, cover and hold on.

- Get under a sturdy desk or table and hang on to it OR move into a hallway OR get against an interior wall.
- Stay clear of windows, fireplaces, and heavy furniture or appliances.
- Get out of a kitchen or any area that has numerous objects that can fall.
- Do not run downstairs or rush outside while the building is shaking. Debris may be falling and/or you might fall and sustain an injury.

If you are outdoors: Get into an open area.

Move away from buildings, power lines, chimneys, and anything else that might fall on you.

If you are driving: Prepare to stop.

- Move as far out of traffic as possible.
- Do not stop on or under a bridge or overpass or under trees, light poles, power lines, or signs.
- Remain in your car until the shaking stops.
- After you resume driving, watch for cracks or bumps in the road and fallen objects.

If you are near a steep hillside: Watch for landslides.

Earthquakes can loosen rocks, trees, and other debris.





COASTAL AREAS: SPECIAL TSUNAMI PRECAUTIONS

An earthquake or large landslide near the coast or beneath the ocean can cause a tsunami. A tsunami may occur without warning, and the first waves—which often are not the largest—may reach the coast within minutes after the initial earthquake. And, an earthquake may result in more than one set of waves; potentially deadly tsunami waves can continue to arrive for hours and at intervals of 10 minutes or more.

During the shaking: Drop, cover, and hold on.

Watch for falling objects until the shaking stops.

After the shaking: Move (evacuate) immediately either to higher ground or inland away from the shore, and do so on foot if you cannot evacuate by vehicle. Note: Authorities may have no time to issue a warning. If you do not hear an evacuation announcement but you see a drop or rise in water level or you hear a loud noise coming from the water, move immediately and quickly away from the shore.

Stay away from the shore. Wait for an official “all clear” announcement before you return to the area.



Aftershocks may occur and you may need to continue to take precautions even after the initial earthquake.

Precautions: After an Earthquake

Check for Injuries

- If a person is bleeding, put direct pressure on the wound. Use clean gauze or cloth, if available.
- If a person is not breathing, immediately call 911. If you can, perform CPR.
- Seek medical help for other serious injuries.
- Do not attempt to move a person who is seriously injured unless there is an immediate danger of further injury.
- Cover injured persons with blankets to keep them warm.

Check for Hazards

- **Fires:** If safe to do so, immediately extinguish a fire. Otherwise, call 911.
- **Gas leaks:** If you suspect a gas leak or smell natural gas (rotten eggs), shut off the main gas valve. **Note:** Once you turn off the gas, do not turn it back on yourself. Wait for the gas utility company to check for leaks and have the company restore your service.
- **Damaged electrical wiring:** Shut off your power at the control box.
- **Downed or damaged utility lines:** Do not touch downed power lines or any objects in contact with them. Contact the local electric utility company.
- **Spills:** If you can do so safely, clean up any spilled medications or spills of other potentially harmful materials such as bleach, lye, or gasoline.
- **Downed or damaged chimneys:** Approach chimneys with caution; they may be weakened and could topple during aftershocks. Do not use a fireplace with a damaged chimney; the damage could cause a fire or leak toxic fumes into the home.
- **Broken glass:** To avoid injuries, be sure to wear sturdy shoes.
- **Fallen objects:** Look for objects that have fallen, being careful as you check closets and cupboards for objects that still might fall.



Check Food and Water Supplies

- **Lack of electricity and meal planning:** If you have no electricity, plan to first eat refrigerated and frozen foods that will spoil quickly. Refrigerated and frozen food will keep for at least two days if you do not open the doors too often.
- **Using the stove:** If you suspect a gas leak, do not turn on a stove. Even an electric stove can create a spark that could cause an explosion.
- **Outdoor cooking:** Only use barbecues or camp stoves outdoors. Do not use them indoors.



Other Information

The pages that follow provide additional information that homeowners may find useful.

Additional Resources

A number of additional resources on seismic safety and earthquake safety for homeowners are available both from the California Seismic Safety Commission and the Federal Emergency Management Administration (FEMA).

- California Seismic Safety Commission:
www.ssc.ca.gov/forms_pubs/hog.html
- FEMA: www.fema.gov
- California Building Standards Commission:
www.dgs.ca.gov/BSC/Codes

IN THIS SECTION	PAGE
Additional Resources	34
Relevant State Seismic Safety Laws	35
Earthquake Insurance	37
Acknowledgments	38



Relevant State Seismic Safety Laws

The full wording of these laws is available at <http://leginfo.legislature.ca.gov/faces/codes.xhtml>

Publishing the Guide (Business and Professions Code, Section 10149)

The California Seismic Safety Commission is required to develop, adopt, publish, and update the *Homeowner's Guide to Earthquake Safety*, containing information on geologic and seismic hazards, explanations of structural and nonstructural earthquake hazards, and recommendations for mitigating these hazards.

Delivering this Guide (Government Code, Section 8897.1- 8897.5)

Sellers of homes built before 1960 with one to four units of conventional light-frame construction must deliver to the buyer "as soon as practicable before the transfer" a copy of the *Homeowner's Guide to Earthquake Safety* and disclose certain earthquake deficiencies. The seller's real estate agent must provide the seller with a copy of this Guide to give to the buyer.

Water Heater Bracing (Health and Safety Code, Section 19211)

Water heaters must be anchored or strapped to resist falling during an earthquake. The seller must certify to the potential buyer that the water heater is properly braced.

Disclosing Risks (Civil Code, Section 1102 and following sections)

Sellers of real property must disclose known defects and deficiencies in the property—including earthquake risks and hazards—to prospective buyers.

Disclosing Natural Hazards (Civil Code, Section 1103)

Sellers of real property must disclose, using the statutory Natural Hazard Disclosure Statement, whether the property is within any of the seven mapped natural hazard areas, including those areas with earthquake faults or those areas with potential for landslides or liquefaction.

Earthquake Faults (Public Resources Code, Section 2621 and following sections)

The Alquist-Priolo Earthquake Fault Zoning Act prohibits building for human occupancy astride active faults and requires sellers of existing residences to disclose to potential buyers, on a Natural Hazard Disclosure Statement, if the property is located in a designated fault zone.

Landslide and Liquefaction (Public Resources Code, Section 2694 and following sections)

The Seismic Hazard Mapping Act requires the State to prepare maps of the zones in California most susceptible to landslide and liquefaction hazards during earthquakes and requires sellers to disclose to buyers, on a Natural Hazard Disclosure Statement, if the property is in such a zone.



Earthquake Insurance

Companies that sell residential property insurance in California are required by law to offer earthquake insurance to homeowners both at the time of initial sale of the policy and then every two years at the time of policy renewal.

The cost of earthquake insurance coverage is based on a number of factors, including a home's location, age, construction type, and value.

Every home is different. In considering earthquake insurance, a homeowner should evaluate the home's individual risk factors and then weigh the cost of earthquake coverage against the benefits. In other words, a homeowner should determine a home's potential for earthquake damage and the cost of repairs and compare these costs against the cost of coverage (less the deductible that is applicable to the policy). The advice of a licensed civil or structural engineer or architect can be helpful in determining a home's potential for damage and expected costs of repairs.

The California Earthquake Authority (CEA) website has an online calculator to help estimate earthquake insurance premiums. The calculator uses ZIP code, insured value, dwelling type, and desired coverage and deductible to estimate the premiums.

The CEA is required to provide, and the insurance companies are required to disclose, the availability of discounts on earthquake insurance premiums for older homes that have been strengthened to resist earthquake damage.

Residential insurance agents can also help homeowners locate earthquake insurers and estimate annual premiums.

California Earthquake Authority
www.EarthquakeAuthority.com

California Department of Insurance
www.insurance.ca.gov

Acknowledgments

California Seismic Safety Commission

Hon. Michael Gardner, Chair, Local Government
Mia Marvelli, Vice Chair, Building Standards Commission
Ida A. Clair, Acting State Architect
Hon. Ken Cooley, State Assembly (Alternate: Elizabeth Hess)
Mark Ghilarducci, Office of Emergency Services
Hon. Jerry Hill, State Senate (Alternate: Caitlin Armstrong)
Dr. Jorge Fernando Meneses, Geotechnical Engineer
Dr. Kit Miyamoto, Structural Engineer
Hon. David Rabbitt, Local Government
Hon. Cindy Silva, Local Government
Timothy Strack, Fire Protection
Fuad Sweiss, Mechanical Engineer
Andrew (Andy) Tran, Insurance
Ivan Wong, Seismologist

Commission Staff

Richard McCarthy, Executive Director
Robert Anderson
Lena Daniel
Michael Orille
Fred Turner
Salina Valencia

The Commission appreciates the assistance of the following organizations and individuals in preparing this version and prior versions of the Guide:

American Red Cross	City of Los Angeles
American Society of Home Inspectors	Earthquake Engineering Research Institute
Association of Bay Area Governments	Randy Goodwin, City Architect/Building Official, City of West Sacramento
AT&T (SBC)	Humboldt Earthquake Education Center
Building Education Center	International Code Council
California Association of Realtors	San Diego Association of Governments
California Building Officials	Southern California Association of Governments
California Council of the American Institute of Architects	Southern California Gas Company/SEMPRA
California Geological Survey	Structural Engineers Association of California
California Real Estate Inspection Association	
California Governor's Office of Emergency Services	